



D-901

ALL-IN-ONE MODULAR DIGITAL MIXER



Compact, modular design with a 12 in/ 8 out configuration for a variety of source equipment, with automixing, feedback suppression, equalization, 16 memory presets and full remote control capability.

High-resolution sound quality and remote control all-in-one modular digital mixer.



D-901

Ready for any requirement.

The new TOA D-901 Digital Mixer is a fully modular, cost-effective digital mixer featuring a 12-input, 8-bus, 8-output channel configuration (12 x 8 matrix) with easy operation that can be expanded as applications require.

All-in-one design.

The compact D-901 is just 3U-sized but incorporates several of the most important functions. These include a digital mixer, feedback suppression, auto mixing, parametric EQ, compression, delay and echo. Its remarkable operational scope allows it to do the work that conventionally requires several different pieces of equipment, providing a cost-effective solution that is perfect for any requirement.

Feedback suppressor.

This sophisticated and TOA proprietary function automatically processes feedback at certain frequencies through constant monitoring then automatically attenuates only the precise problematic frequencies, keeping the audio sounding natural.

Automatic mixing function.

The D-901's automatic mixing function adjusts input level automatically to make operating easier. It features smart Number of Open Microphones (NOM) attenuation that sets the gain for all microphone inputs according to the number of microphone inputs utilized. This allows satisfactory levels to be set without feedback problems. A "Ducker" function operates when an input channel is open, to enable that channel's priority to initiate the low channel signal that will attenuate the other channels.

Sound processing.

As a full-featured digital mixer, the D-901 incorporates several useful built-in functions to ensure maximum performance without needing other equipment. A compressor can be switched in to reduce the dynamic range between the smallest and largest signals, preventing amplifier clipping at high levels. The flexible crossover function allows setting speaker crossover points and filter slopes to optimize multichannel speaker systems. Full equalization and filter setting configurations can be saved in up to sixteen memories for instant recall. The time delay function can be used to align remote speakers.

Ergonomic control layout.

Convenient front panel controls and display make it easy to perform all functions and confirm parameter settings without requiring a PC. Another advantage is the ability to store up to 16 sound parameter setting configurations in memory for instant recall when required. These include crossover, EQ, filter slope settings, time delay and other parameters. Control settings can also be locked to prevent unauthorized tampering.

Wide application scope and remote control ability.

The D-901 can be externally controlled with an external signal trigger or the RS-232C port on the back panel which enables the D-901 to easily interface with external equipment.

Note: The D-901's heatsinks and aircooling are located at the bottom of the unit, requiring a perforated ventilation panel to be placed directly below the unit when rack-mounting is desired.

ote control capability in a compact,

Compression

All audio below a selected threshold is allowed to pass while audio above the threshold is compressed, reducing the dynamic range of the loudest sounds. This prevents signals from clipping and distortion.

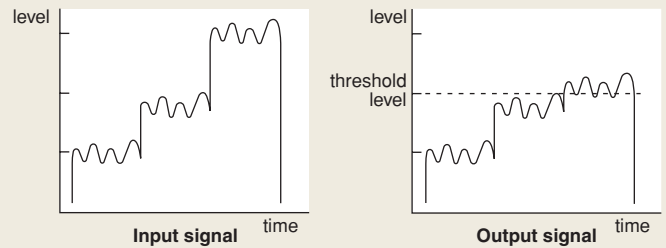

Feedback Suppression

Conventional suppression

Manual cancellation of feedback is imprecise as filtering problem frequencies affects neighboring frequencies as well. This tonally impacts the signal and often results in audio that does not sound natural.

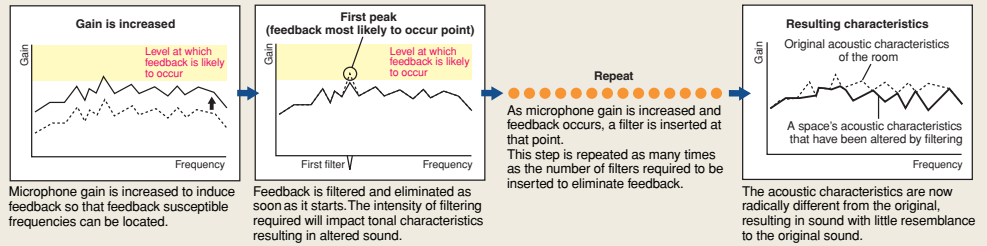

TOA feedback suppressor

This proprietary technique works by automatically detecting the frequencies where acoustic feedback is occurring. Once these frequencies are detected, the suppressor automatically sets precise notch filters that drastically attenuate just those those frequencies with accurate pinpoint filtering.

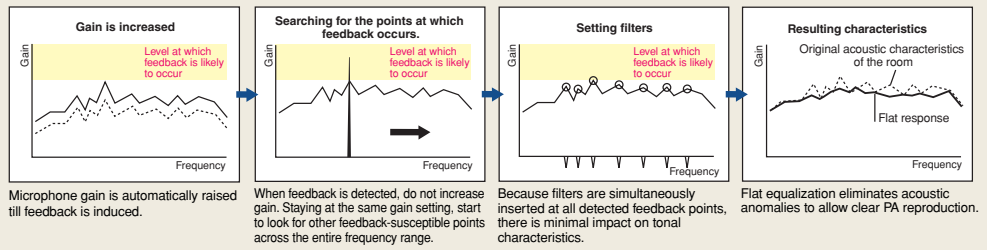

Audio signals are therefore minimally affected because only the problem frequencies are attenuated to negligent levels through the suppressor's action.

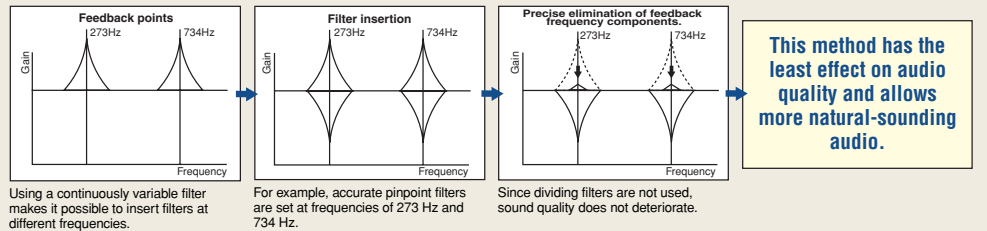

D-901 PC Software

The D-901 comes standard with dedicated software to assist in D-901 system configuration, parameter setting and general setup using a PC. The software features menu-driven operation with an easy to understand GUI. The software offers comprehensive control over virtually every possible function. For set up these include crossover slopes, combinations, and storing crossover configurations. For operation, menus offer dedicated pages for viewing and adjusting matrix, trim, EQ, compression, automix, gating, filtering, delay, echo and feedback suppression settings as well as mic/line input modules and many others. Presets can be configured and stored for immediate recall when desired. In addition, the software allows determining user level as well as preparing the D-901 for remote control. Lastly, a full assortment of protection functions can be utilized.

* Download installation program from TOA's homepage (<http://www.toa-products.com/international/>) and save it to the desktop.

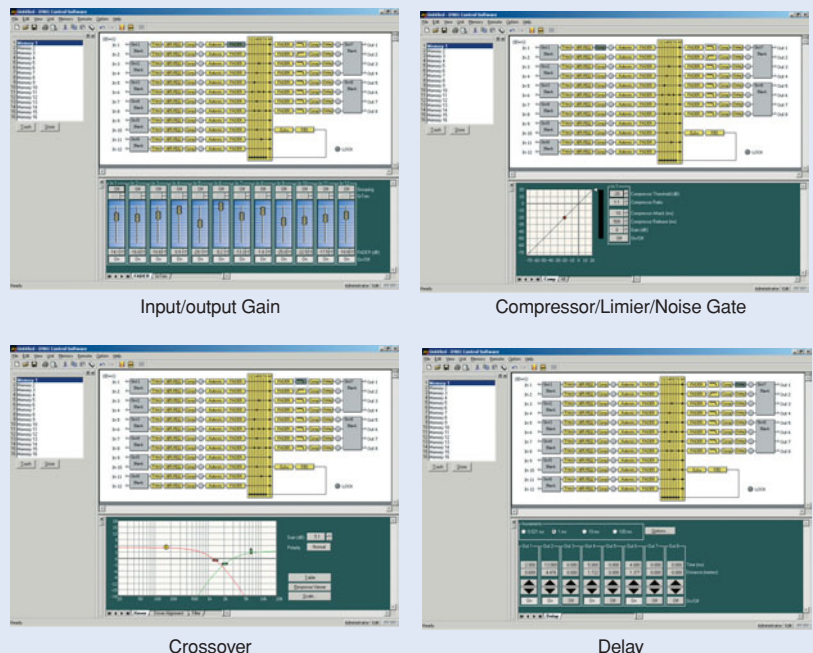

D-901 rear



D-901 Modules

The D-901's modular design allows you to configure the most cost-effective design for each application. TOA offers a range of modules to suit a variety of input and output requirements.

INPUT MODULES

Mic/Line Input Modules

Monaural type

A/D Converter

XLR Connector

Removable Terminal Block Connector

20 bit

D-922F

2-Channel input module for mic and line inputs (selectable) with XLR connectors and DIP switches for input sensitivity, phantom power and ground lift.



D-922E

2-Channel input module for mic and line level inputs (selectable) with removable terminal block connectors, input sensitivity DIP switches, phantom power and ground lift.



24 bit

D-921F

2-Channel input module for mic and line inputs (selectable) with XLR connectors, adjustable input sensitivity, and phantom power.



D-921E

2-Channel input module for mic and line level inputs (selectable) with removable terminal block connectors, adjustable input sensitivity and phantom power.



Stereo type

D-936R

4 stereo input module equipped with standard RCA jacks. This module features two stereo transmission mode:



- 1) Selection of one of the four stereo inputs.
- 2) Mixing of all four stereo inputs, transmitting the mixed signal to the D-901 through left/right channel outputs.

Digital Input Modules

Applicable AES/EBU Format

D-923AE

2-Channel digital input module. With the use of this module, digital signals can be input, permitting direct connection of the D-901 to equipment having a digital output. Owing to the built-in sample rate converter, the module can handle signals of various sampling frequencies.



Applicable S/PDIF Format

D-937SP

Single channel stereo digital input module. With the use of this module, digital signals can be input, permitting direct connection of the D-901 to equipment having a digital output. Owing to the built-in sample rate converter, the module can handle signals of various sampling frequencies.



OUTPUT MODULES

Line Output Modules*

XLR Connector

D-971M

4-channel line outputs module equipped with XLR connectors.



Removable Terminal Block Connector

D-971E

4-channel line outputs module equipped with removable terminal block connectors.



RCA Pin Jack Connector

D-971R

4-channel line outputs module equipped with standard RCA pin jack.



Digital Output Modules

Applicable AES/EBU Format

D-972AE

4-channel digital output module. With the use of this module, digital signals can be output, permitting direct connection of the D-901 to equipment having a digital input.



Applicable S/PDIF Format

D-961SP

2-Channel stereo digital output module. With the use of this module, digital signals can be output, permitting direct connection of the D-901 to equipment having a digital input.



* Slots 5-8 accommodate only two D-971M and/or D-971E Line Output Modules together or independently in total.

REMOTE CONTROL MODULES

Remote Control Module

8 inputs
8 outputs

D-981

For external remote control of memory presets, gain control, stereo input selection and channel ON/OFF operation plus tally outputs.



24 inputs
16 outputs

D-983

For external remote control of memory presets, gain control, stereo input selection and channel ON/OFF operation plus tally outputs.

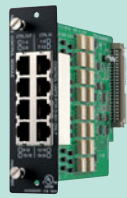

VCA Control Module

VCA control (20 channels) + 8 inputs
8 outputs

D-984VC

By the VCA controls from external equipment, this module permits the D-901's gains of 12 inputs and 8 outputs to be controlled. By the contact input controls from external equipment, it permits preset memory recall, gain control, stereo input selection and channel ON/OFF operation plus tally outputs.



D-901 Control Unit

A dedicated VCA fader unit that significantly expands the operational scope of the D-901 Digital Mixer. It adds useful control capabilities when connected to the D-984VC. In such a connection setup, full VCA operation becomes possible, allowing all the D-901's 12 inputs and 8 outputs channel gain levels and 8 contact controls.

VCA FADER UNIT

D-911

VCA fader unit for controlling 12 inputs/ 8 outputs, channel gains and 8 contact controls when used with the D-984VC.

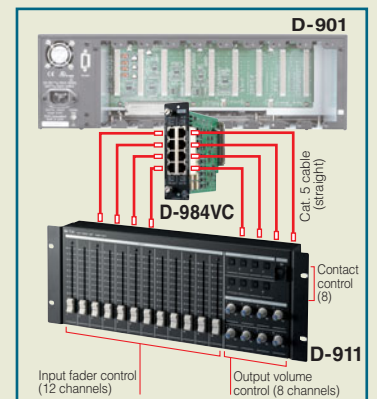
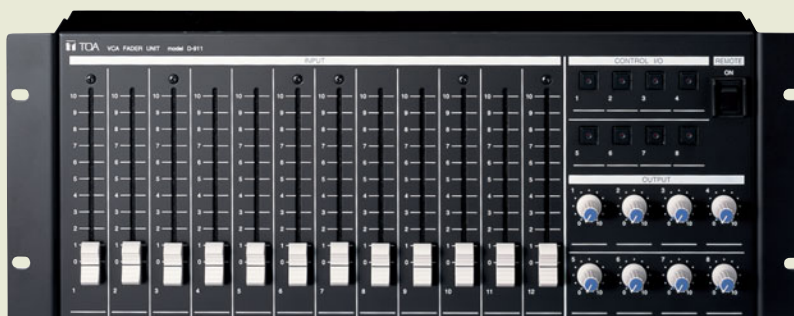

Examples of common system configurations

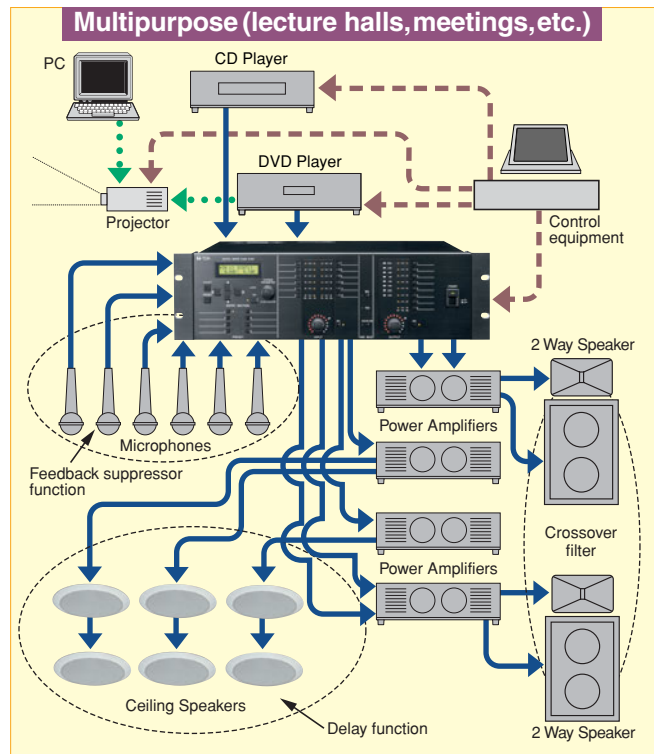
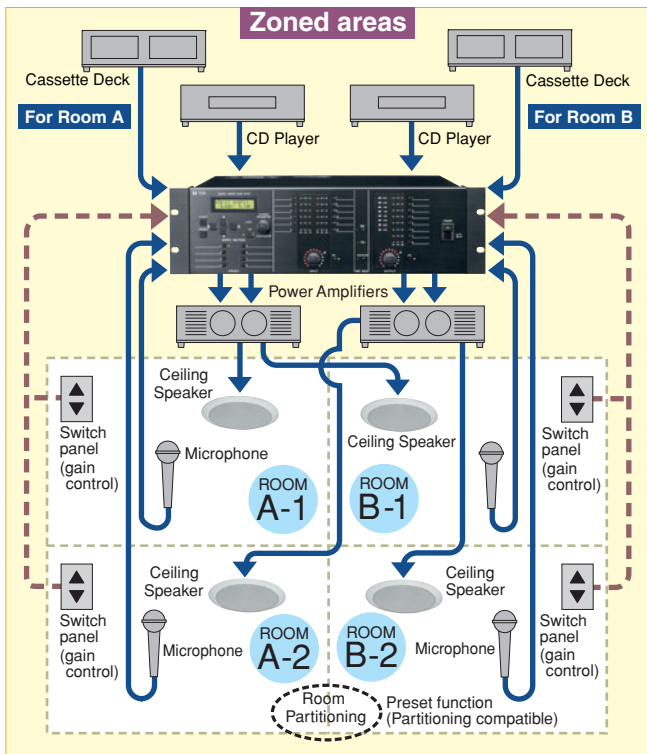
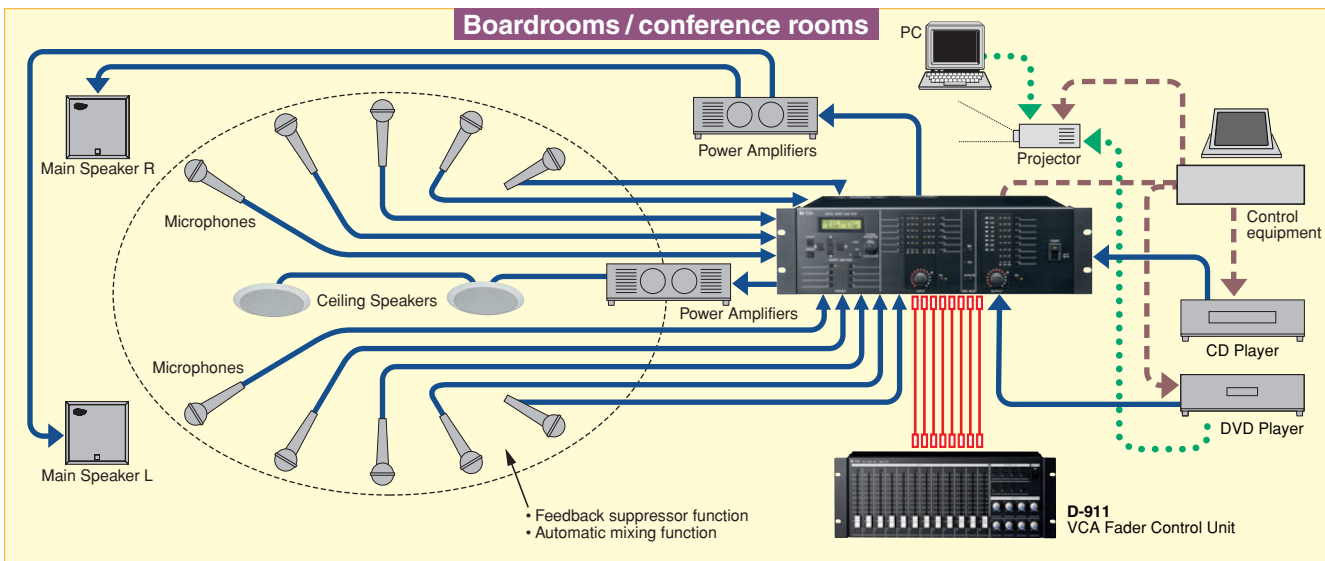
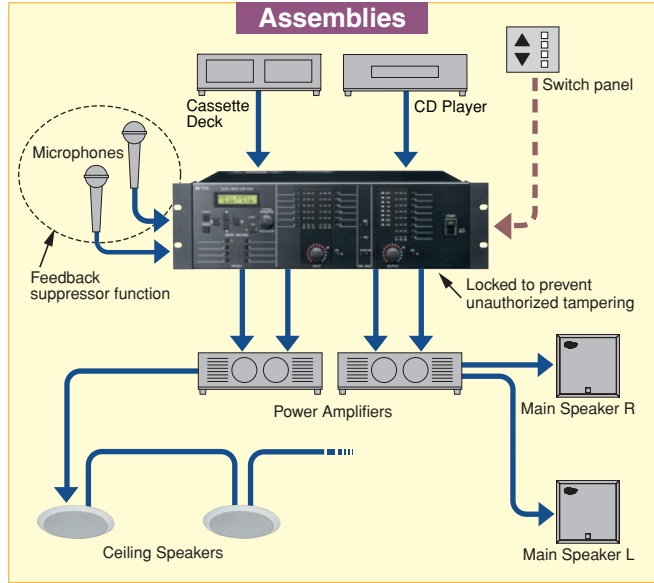
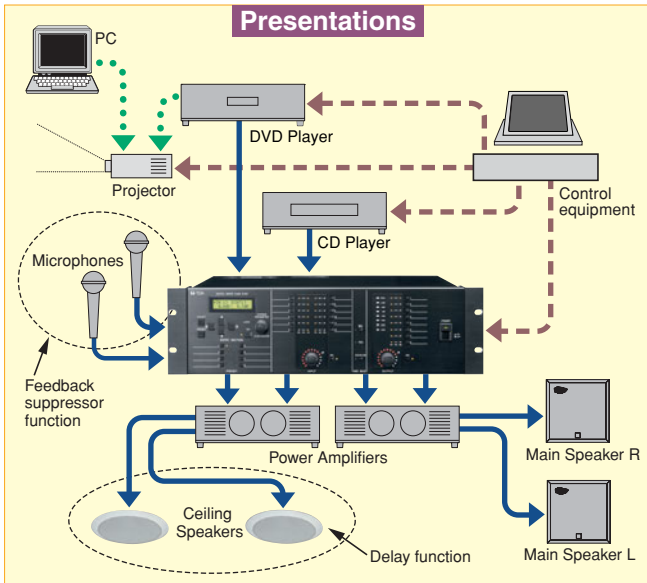

••••• Video - - - - - Control ——— Sound

Main Unit Specifications

■ D-901 Main Unit (Installation rackmount only)

*1 0dB = 0.775V

Power Source	100 – 120V, 230V AC, 50/60Hz				
Power Consumption	40W				
Operating Temperature	+5°C to +40°C				
Frequency Response	20 – 20,000Hz, ±1dB (±4dB*1 Input)				
Input	Max. 12 channels, modular construction (modules optional)				
Output	Max. 8 channels, modular construction (modules optional)				
Signal Processing					
Feedback Suppression Function	12 filters (auto/dynamic)				
Auto Mixing Function	Ducker (automatic muting), NOM attenuation				
Auto Mixing Group	4 groups				
Equalizer / Filter	Parametric equalizer:	20 – 20,000Hz, ±15dB, Q: 0.267 – 69.249			
	Filtering: High-pass filter	20 – 20,000Hz, 6 dB/oct, 12dB/oct	Low-pass filter	20 – 20,000Hz, 6 dB/oct, 12dB/oct	
	Notch filter	20 – 20,000Hz, Q: 8.651 – 69.249	All-pass filter	20 – 20,000Hz, Q: 0.267 – 69.249	
	High shelving filter	6 – 20,000Hz, ±15dB	Low shelving filter	20 – 500Hz, ±15dB	
	Horn equalizer	20kHz, 0 to +18dB (1dB steps)			
	Crossover filter:	20 – 20,000Hz, 6dB/oct, 12 dB/oct, 18dB/oct, 24dB/oct			
Compressor/ Auto-Leveler	(Compressor mode)				
	Threshold:	–20 to +20dB (1dB steps)			
	Ratio:	1:1, 2:1, 3:1, 4:1, 8:1, 12:1, 20:1, ∞:1			
	Attack time :	0.2ms – 5s			
	Release time:	10ms to 5s			
	Gain:	–∞ to +10dB			
	(Auto-leveler mode)				
	Target level:	–20 to +10dB			
	Maximum gain:	0 to +20dB (1dB steps)			
	Attack time :	10ms – 10s			
Release time:	100ms to 10s				
Delay	Delay time: 0 – 682.6ms (0.021ms steps)				
Matrix	12 x 8				
Crosspoint Gain	–∞ to 0dB (1dB steps)				
Preset memory	16				
Auxiliary Function	System Locking function				
Control	RS-232C, D-sub connector (9 pins), Remote control module (option)				
Front Panel Section	Preset memory recall key: 8, LCD Screen, Screen shift key (up/down/left/right), setting knob Input level indicator: Dual color LED, Output level indicator: Dual color LED Channel selector key: 12 (input channel selection) 8 (output channel selection), Channel volume control: 1 (input channel selection) 1 (output channel selection)				
Rear Panel	Input module slot: 6 (input/output module slot: 2) Output module slot: 2 Remote control module slot: 1				
Finish	Panel: Aluminum, hair-line finish, black Others: Pre-coated steel plate, black, 30% gloss				
Dimensions	482.6 (W) x 132.6 (H) x 320 (D)mm (excluding projection)				
Weight	6.9kg				
Accessory	Power cord (2m) x 1, Rack mounting screw x 4, Rack mounting bracket (preinstalled on the unit) x 2, Module mounting screw (spare) x 4, Blank panel (preinstalled on the module slot) x 9, Fiber washer x 4				

Note: When installing the unit, never block the intake vents provided in the unit's bottom near the rear.

Input Modules Specifications

● Mic/Line Input Modules

*1 0dB = 0.775V

Model	D-921F	D-921E*2	D-922F	D-922E*2	D-936R
Input	2 channels, Mic/Line changeable Mic: –50/–36dB*1, 4.7kΩ, electronically-balanced Line: –10/+4dB*1, 10kΩ, electronically-balanced Phantom power supply (+15V, can be used when set for the microphone) Ground lift switch		2 channels, –50/–36/–10/+4dB*1 (Selectable with the DIP switch), 4.7kΩ, electronically-balanced Phantom power supply (15V, can be set with the DIP switch) Ground lift switch (can be set with the DIP switch)		4 stereo inputs (selection of 1 stereo or mixing or all 4 stereo inputs) –10dB*1, 10kΩ
Connector Type	XLR-3-31	Removable terminal block	XLR-3-31	Removable terminal block	RCA pin jack
A/D Converter	24 bits		20 bits		24 bits
Frequency Response	20 – 20,000Hz, ±1dB (+4dB*1 input)				
Sampling Frequency	48kHz				
Dynamic range	Over 100 dB (IHF-A weighted) (+4dB*1 input)		Over 85dB (IHF-A weighted) (+4dB*1 input)		Over 100dB (IHF-A weighted)
Total Harmonic Distortion	Under 0.05% (+4dB*1 input)		Under 0.2% (+4dB*1 input)		Under 0.05%
Finish	Panel: Pre-coated steel plate, black, 30% gloss				
Dimensions	35 (W) x 119.5 (H) x 178.4 (D) mm				
Weight	150g	140g	135g	125g	145g

*2 Accessory: (D-921E/D-922E) Removable terminal block type connector (preinstalled on the unit) x 2

● Digital Input Modules

Model	D-923AE	D-937SP
Input	2 channels, 2.0 – 7.0V (p-p), 110Ω, XLR-3-31 or equivalent	Stereo 1 channel line (Selectable one of four inputs), 0.5V (p-p), 75Ω, Coaxial RCA jack x 2 Square optical connector x 2
Applicable Format	AES/EBU (2 channel multiplexed)	S/PDIF (2 channel multiplexed)
Sampling Frequency	32 – 48kHz	
Finish	Panel: Pre-coated steel plate, black, 30% gloss	
Dimensions	35 (W) x 119.5 (H) x 178.4 (D) mm	
Weight	130g	

Output Modules Specifications

● Mic/Line Output Modules

*1 0dB = 0.775V

Model	D-971M	D-971E**2	D-971R
Output	4 channels, +4dB*1, adaptable load of over 600Ω, electronically-balanced		4 channels (2 outputs for each channel), -10dB*1, adaptable load of over 600Ω
Connector Type	XLR-3-32	Removable terminal block	RCA pin jack
D/A Converter		24 bits	
Sampling Frequency		48kHz	
Frequency Response		20 – 20,000Hz, ±1dB	
Dynamic range		Over 100dB (IHF-A weighted)	
Total Harmonic Distortion		Under 0.05%	
Finish		Panel: Pre-coated steel plate, black, 30% gloss	
Dimensions		35 (W) x 119.5 (H) x 178.4 (D)mm	
Weight	165g	140g	150g

● Digital Output Modules

Model	D-961SP	D-972AE**2
Output	Stereo 2 channel line (with splitter, can be output to each pair of optical output and coaxial output in Parallel), 0.5V (p-p), 75Ω, Coaxial RCA jack x 2 Square optical connector x 2	4 channels, 5.0V (p-p), 110Ω, XLR-3-32 or equivalent x 2
Applicable Format	S/PDIF (2 channel multiplexed)	AES/EBU (2 channel multiplexed)
Sampling Frequency		48kHz
Finish		Panel: Pre-coated steel plate, black, 30% gloss
Dimensions		35 (W) x 119.5 (H) x 178.4 (D) mm
Weight		130g

Remote Control Modules Specifications

● Remote Control Modules

Model	D-981**2	D-983
Contact input	COM + terminals 1-8: Open voltage: 5V DC, short-circuit current: 5mA removable terminal block type connector	COM + terminals 1-24: Open voltage: 5V DC, short-circuit current: 5mA RJ45 connector x 4
Control	<p>Any preset memory can be recalled. Control method: No-voltage make of over 100ms/no-voltage make single pulse of over 100ms</p> <p>Any input/output channel volume can be turned UP or DOWN. Control method: 1 step variation for no-voltage make single pulse of over 100ms 1 step continuous operation for every 70ms for no-voltage make of over 100ms. Can be reset when at break.</p> <p>Variable range; -∞dB to +10dB Any input/output channels can be turned ON and OFF. Control method: No-voltage make of over 100ms/no-voltage make single pulse of over 100ms</p> <p>Input channel lines of the D-936R (optional) or the D-937SP (optional) (4 stereo input module) can be selected. Control method: No-voltage make of over 100ms/ no-voltage make single pulse of over 100ms</p>	
Contact output	COM + terminals 1-8: No-voltage make contact input, contact capacity: 24V DC, 100mA removable terminal block type connector	COM + terminals 1-16: No-voltage make contact input, contact capacity: 24V DC, 100mA RJ45 connector x 4
Finish	Panel: Pre-coated steel plate, black, 30% gloss	
Dimensions	35 (W) x 119.5 (H) x 178.4 (D)mm	
Weight	125g	170g

● VCA Control Module

Model	D-984VC
VCA control input	+5V GND, Terminal 1 – 20 (12 input channels, 8 output channels), RJ45 connector x 4 Control contents: Volume control of each input/output channel Variable range: -∞dB to +0dB
Contact input	COM + terminal 1-8: Open voltage: 5V DC, short-circuit current: 5mA, RJ45 connector x 2
Control	<p>Any preset memory can be recalled. Control method: No-voltage make of over 100ms/ No-voltage make single pulse of over 100ms</p> <p>Any input/output channel volume can be turned UP or DOWN. Control method: 1 step variation for no-voltage make single pulse of over 100ms 1 step continuous operation for every 70ms for no-voltage make of over 100ms. Can be reset when at break.</p> <p>Variable range; -∞dB to +10dB Any input/output channel can be turned ON and OFF. Control method: No-voltage make of over 100ms/ No-voltage make single pulse of over 100ms</p> <p>Input channel lines of the D-936R (optional), or the D-937SP (optional) (4 stereo input module) can be selected. Control method: No-voltage make of over 100ms/ No-voltage make single pulse of over 100ms</p>
Contact output	COM + terminal 1-8: No-voltage make contact, contact capacity: 24V DC, 100mA RJ45 connector x 2
Finish	Panel: Pre-coated steel plate, black, 30% gloss
Dimensions	35 (W) x 119.5 (H) x 178.4 (D)mm
Weight	170g

**2 Accessory: (D-971E, D-981) Removable terminal block type connector (preinstalled on the unit) x 2
(D-972AE) Ferrite clamp x 2

VCA Fader Unit Specifications

Model	D-911
Power Supply	5V DC (supplied from the optional D-984VC)
Connector	RJ45 connector x 8
Input Fader Control	Input fader (100mm) x 12
Output Volume Control	Output volume control x 8
Contact Control	Illuminated switch x 8
Remote Output	No-voltage make contact output (contact capacity: 30V DC, 4A)
Remote Switch	Seesaw switch for activating the remote function of the power distributor
Finish	Panel: Pre-coated steel plate, black, 30% gloss
Dimensions	482.6 (W) x 177 (H) x 61.3 (D)mm (excluding projection)
Weight	2.7kg
Accessory	Fader knob (Red, Yellow) x 3 each, Volume knob (Red) x 2, Rack mounting screw x 4, Rack mounting fiber washer x 4, Rack mounting bracket (preinstalled on the unit) x 2

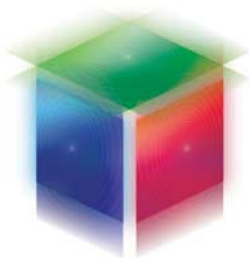

**Human Society with
Sound & Communication**

TOA Corporation
www.toa.jp

Specifications are subject to change without notice.
Printed in Japan (0711) 833-52-301-3C u