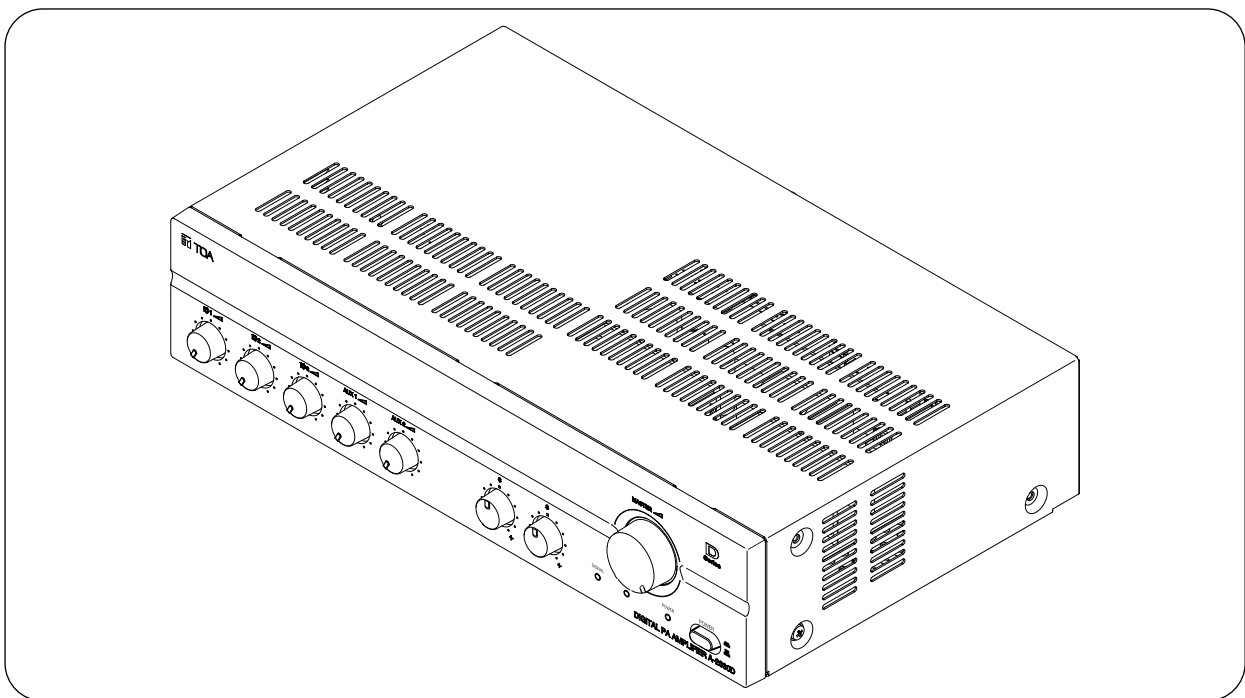

**DIGITAL PA AMPLIFIERS**
**A-2030D-AS**
**A-2060D-AS**
**A-2120D-AS**
**A-2240D-AS**

**TABLE OF CONTENTS**

<b>1. SAFETY PRECAUTIONS</b> .....	2	7.1. Input Connection .....	5
<b>2. GENERAL DESCRIPTION</b> .....	3	7.2. Output Connection .....	6
<b>3. FEATURES</b> .....	3	7.3. Example of External Equipment Connections .....	6
<b>4. NOMENCLATURES AND FUNCTIONS</b>		<b>8. VOLUME CONTROL SETTING</b> .....	6
4.1. Front .....	4	<b>9. BLOCK AND LEVEL DIAGRAMS</b> .....	7
4.2. Rear .....	4	<b>10. DIMENSIONAL DIAGRAM</b> .....	8
<b>5. MUTING FUNCTION</b> .....	5	<b>11. SPECIFICATIONS</b> .....	8
<b>6. HORN FILTER SWITCH</b> .....	5		
<b>7. CONNECTIONS</b>			

Thank you for purchasing TOA's Digital PA Amplifiers.  
Please carefully follow the instructions in this manual to ensure long, trouble-free use of your equipment.

# 1. SAFETY PRECAUTIONS

- Before installation or use, be sure to carefully read all the instructions in this section for correct and safe operation.
- Be sure to follow all the precautionary instructions in this section, which contain important warnings and/or cautions regarding safety.
- After reading, keep this manual handy for future reference.

## Safety Symbol and Message Conventions

Safety symbols and messages described below are used in this manual to prevent bodily injury and property damage which could result from mishandling. Before operating your product, read this manual first and understand the safety symbols and messages so you are thoroughly aware of the potential safety hazards.

### **WARNING**

Indicates a potentially hazardous situation which, if mishandled, could result in death or serious personal injury.

### **CAUTION**

Indicates a potentially hazardous situation which, if mishandled, could result in moderate or minor personal injury, and/or property damage.

## **WARNING**

### When Installing The Unit

- Do not expose the unit to rain or an environment where it may be splashed by water or other liquids, as doing so may result in fire or electric shock.
- Use the unit only with the voltage specified on the unit. Using a voltage higher than that which is specified may result in fire or electric shock.
- Do not cut, kink, otherwise damage nor modify the power supply cord. In addition, avoid using the power cord in close proximity to heaters, and never place heavy objects including the unit itself on the power cord, as doing so may result in fire or electric shock.
- The terminals marked with the symbol  are hazardous live. The external wiring to these terminals requires installation by an instructed person.
- The socket-outlet shall be installed near the equipment and the plug (disconnecting device) shall be easily accessible.
- Be sure to replace the unit's terminal cover after connection completion. Because the voltage of up to 100V is applied to the high impedance speaker terminals, never touch these terminals to avoid electric shock.
- Be sure to ground to the safety ground (earth) terminal to avoid electric shock. Never ground to a gas pipe as a catastrophic disaster may result.

### When The Unit is in Use

- Should the following irregularity be found during use, immediately switch off the power, disconnect the power supply plug from the AC outlet and contact your nearest TOA dealer. Make no further attempt to operate the unit in this condition as this may cause fire or electric shock.
  - If you detect smoke or a strange smell coming from the unit.
  - If water or any metallic object gets into the unit.
  - If the unit falls, or the unit case breaks.
  - If the power supply cord is damaged (exposure of the core, disconnection, etc.)
  - If it is malfunctioning (no tone sounds.)
- To prevent a fire or electric shock, never open nor remove the unit case as there are high voltage components inside the unit. Refer all servicing to your nearest TOA dealer.
- Do not place cups, bowls, or other containers of liquid or metallic objects on top of the unit. If they accidentally spill into the unit, this may cause a fire or electric shock.
- Do not insert nor drop metallic object or flammable materials in the ventilation slots of the unit's cover, as this may result in fire or electric shock.

## CAUTION

### When Installing The Unit

- Never plug in nor remove the power supply plug with wet hands, as doing so may cause electric shock.
  - When unplugging the power supply cord, be sure to grasp the power supply plug, never pull on the cord itself. Operating the unit with a damaged power supply cord may cause a fire or electric shock.
  - When moving the unit, be sure to remove its power supply cord from the wall outlet. Moving the unit with the power cord connected to the outlet may cause damage to the power cord, resulting in fire or electric shock. When removing the power cord, be sure to hold its plug to pull.
  - Do not block the upper panel ventilation slots in the unit's cover. Doing so may cause heat to build up inside the unit and result in fire.
- Avoid installing the unit in humid or dusty location, in location exposed to direct sunlight, near the heaters, or in location generating sooty smoke or steam. As doing otherwise may result in fire or electric shock.
  - Keep the distance for all side of units 10 cm away from the object that may obstruct air flow for internal units temperature rise prevention.

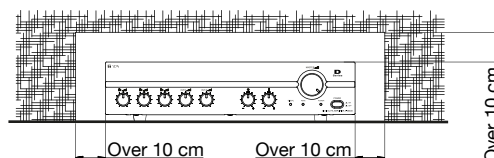

### When The Unit is In Use

- Do not place heavy object on the unit as this may cause it to fall or break which may result in personal injury and/or property damage. In addition, the object itself may fall off and cause injury and/or damage.

## 2. GENERAL DESCRIPTION

TOA's Digital PA Amplifiers A-2030D-AS, A-2060D-AS, A-2120D-AS and A-2240D-AS are high performance mixer power amplifier suited for broadcasting paging or background music in schools, offices, shop, factories, mosque, churches and large room.

## 3. FEATURES

- High durability, high reliability and high performance.
- Three microphone inputs, two AUX input and one recording output.
- Speaker output of constant voltage distribution system (100V).
- Operates on AC power.
- Muting function.
- Independent input volume control and master volume control.
- Independent tone control of boost and cut type for both high and low frequency.
- MIC 1 with phantom power for condenser microphone.
- Current limiter circuitry protects transistor and thermal protection circuitry prevent a failure due to overheat.
- All MIC inputs are electronically-balanced input.

## 4. NOMENCLATURES & FUNCTIONS

### [Front]

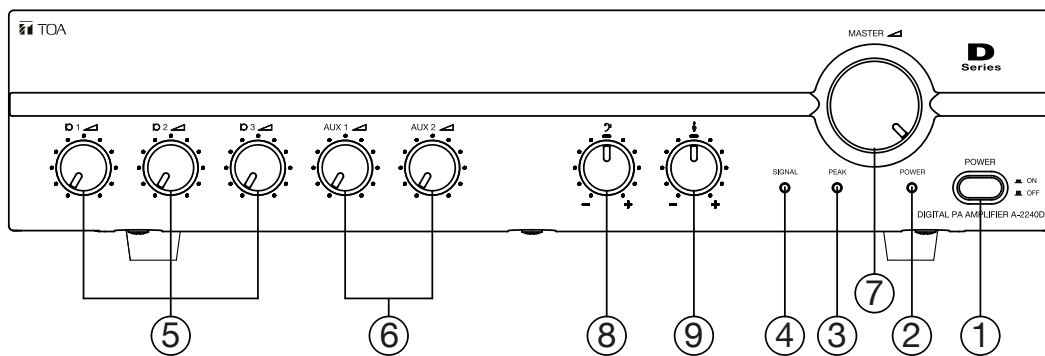

### [Rear]

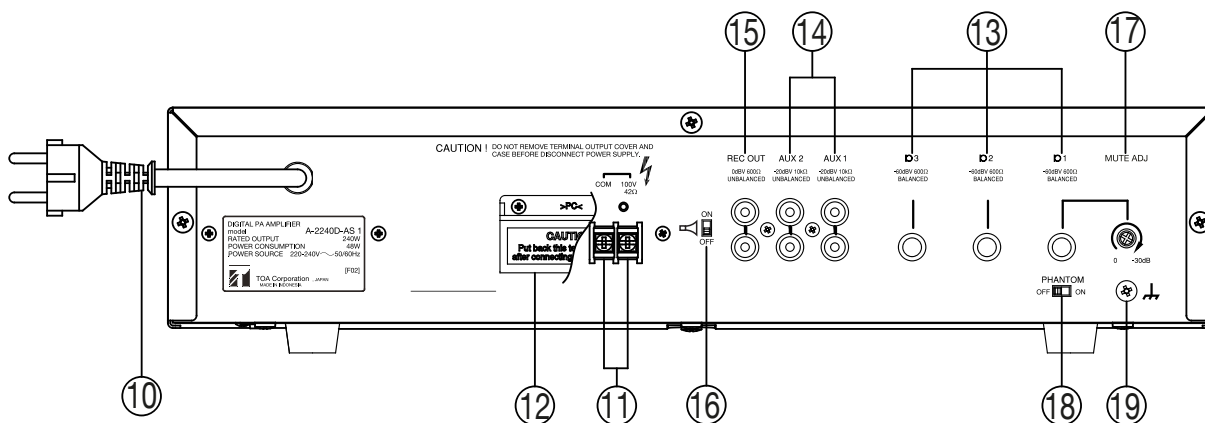

#### 1. Power Switch

Press to turn ON the power.  
Press again to turn off the power

#### 2. Power Indicator

Lights green when power is switched ON

#### 3. Peak Indicator

Lights red to indicate the output signal reaches the peak level, this indicates that sound is distorted. In such case, adjust each volume control to reduce output level.

#### 4. Signal Indicator

Lights green for indicates present of an output signal.

#### 5. Microphone Volume Control

Adjust the microphone level.

#### 6. AUX Volume Control

Adjust the AUX level.

#### 7. Master Volume Control

Adjust overall signal level.

#### 8. Bass Control

Adjust bass response. Rotate clockwise to increase bass output and counterclockwise to reduce it. The center position provide flat characteristic.

#### 9. Treble Control

Adjust treble response. Rotate clockwise to increase treble output and counterclockwise to reduce it. The center position provide flat characteristic.

#### 10. AC Power Cord

Connect to an AC power source.

#### 11. Output Terminal

Terminal for connecting speaker. Use only with high impedance speaker.

#### 12. Terminal Cover

To avoid electric shock by high voltage from output terminal, put back terminal cover after connecting speaker cords.

#### 13. MIC 1, MIC 2 & MIC 3

##### • (MIC 1 : Double Pole Phone Jack)

-60dB (1mV), 600Ω, electronically balanced. Not only a dynamic microphone but also phantom powered microphone can connect with only this MIC 1 input.

##### • (MIC 2 & MIC 3 : Double Pole Phone Jack)

-60dB (1mV), 600Ω, electronically balanced. Because microphone input is balanced type, phone plug uses double pole type, but also can use even single pole type.

#### 14. AUX 1 & AUX 2 Input Terminal

-20dB, 10kΩ, unbalanced. Monaural RCA pin jack.  
Accept external equipment output signal.

#### 15. Recording Output

0dB (1V), 600Ω, unbalanced. Output all input signal before the master volume control. Connect to a cassette deck, etc when recording the broadcast content.

#### 16. Horn Filter Switch (only for 120W & 240W Model)

Activate high pass filter when used horn type speaker.  
Factory preset : OFF (filter is inactive).

#### 17. Muting Level Control

Adjust attenuating level from 0 to -30dB.  
Factory preset : -30dB (maximum muting level).

#### 18. Phantom Switch

Selecting to ON position supplies power for condenser microphone from MIC 1. Be sure to select OFF when using the microphone that can not operated on phantom power. The phantom power is 21 V DC.  
Factory preset : OFF

#### 19. Ground Terminal

Connect to ground (earth) to avoid electric shock.

## 5. MUTING FUNCTION

MIC 1 has a priority function. When MIC 1 input is used it take precedence and automatically attenuate the volume of MIC 2, MIC 3, AUX 1 & AUX 2 inputs by 0 up to 30dB, which is adjustable with the MUTE ADJ on rear panel. The attenuation level is preset for -30dB at the factory.

MUTE ADJ



#### Remark : About mute function

- When signal of MIC 1 appear, mute circuit work promptly.
- When signal of MIC 1 disappear, it returns to it previous state about 3 seconds later.

## 6. HORN FILTER SWITCH

Use this filter while using horn speaker with matching transformer type. The filter is very suitable for a horn speaker.



## 7. CONNECTION

### 7.1. Input Connection

- MIC 1, MIC 2, MIC 3 Connection (Phone Plug)

Because MIC input is electronically balanced type, it uses double pole phone plug.

Double Pole Phone Plug

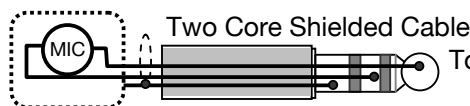

To MIC connector

However, the microphone input circuit is in a condition of unbalance when using single pole type. Since the state of unbalance is more vulnerable for noise generation, the recommended length of microphone cable is at less than 10m.

Single Pole Phone Plug

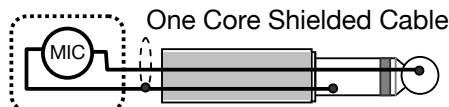

To MIC connector

- AUX Input Connection (RCA Pin Jack)

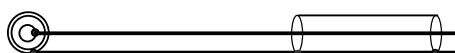

One Core Shielded

Signal source (Tuner, Cassette Tape, etc)

## 7.2. Output Connection

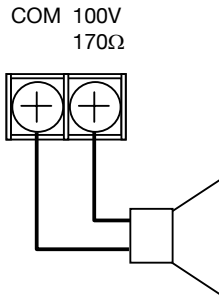

### CAUTION !

Impedances indicate at the terminal represent the total impedance (load) of the speaker system.

Total impedance for 100V line :

- 330Ω (A-2030D-AS)
- 170Ω (A-2060D-AS)
- 83Ω (A-2120D-AS)
- 42Ω (A-2240D-AS)

## ⚠ CAUTION

Be sure to attach the supplies terminal cover after connection completion. Since high voltage is applied to the speaker terminal, never touch these terminals to avoid electric shock.

## 7.3. Example of External Equipment Connections

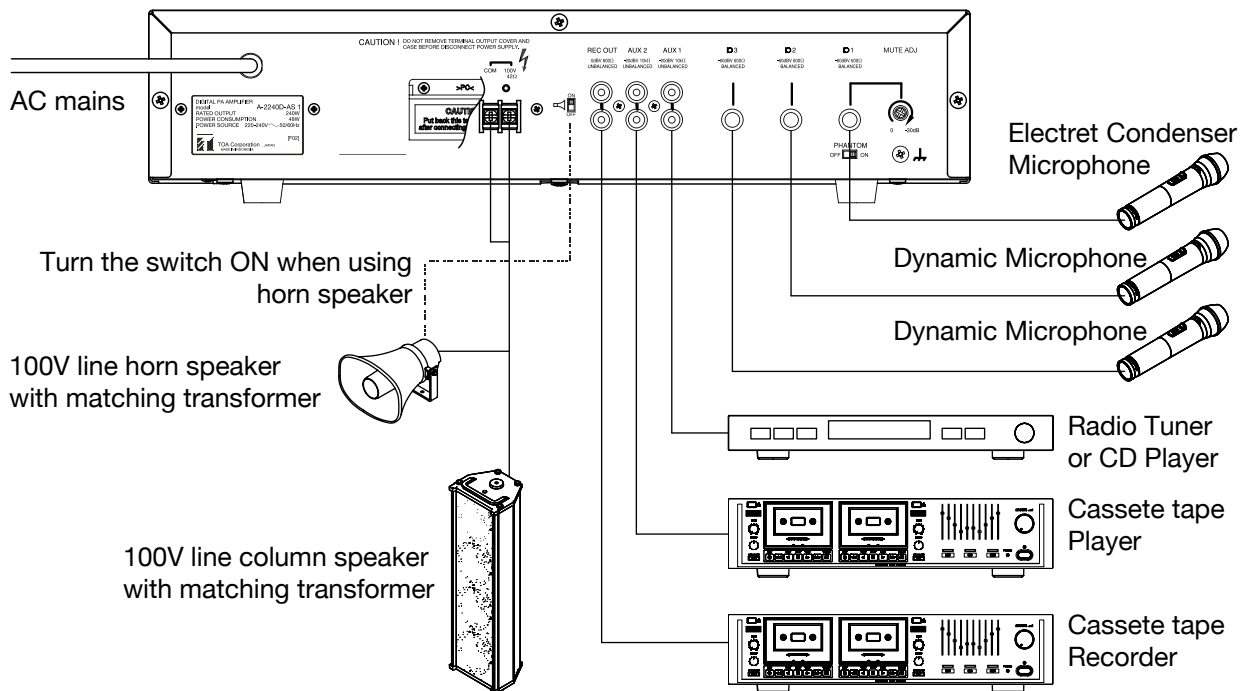

## 8. VOLUME CONTROL SETTING

Output levels are adjustable with individual volume control. Rotate clockwise to increase the volume level & counterclockwise to decrease it. For music play or announcement, adjust the corresponding volume control until the indicator PEAK (red) lights intermittenly. Note that the sound quality is downgraded when the PEAK indicator remains lit.

Factory preset : Minimum

# 9. BLOCK & LEVEL DIAGRAM

## [A-2030D-AS/A-2060D-AS]

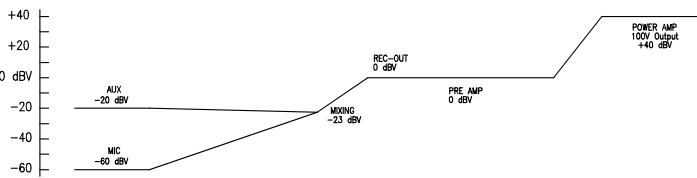
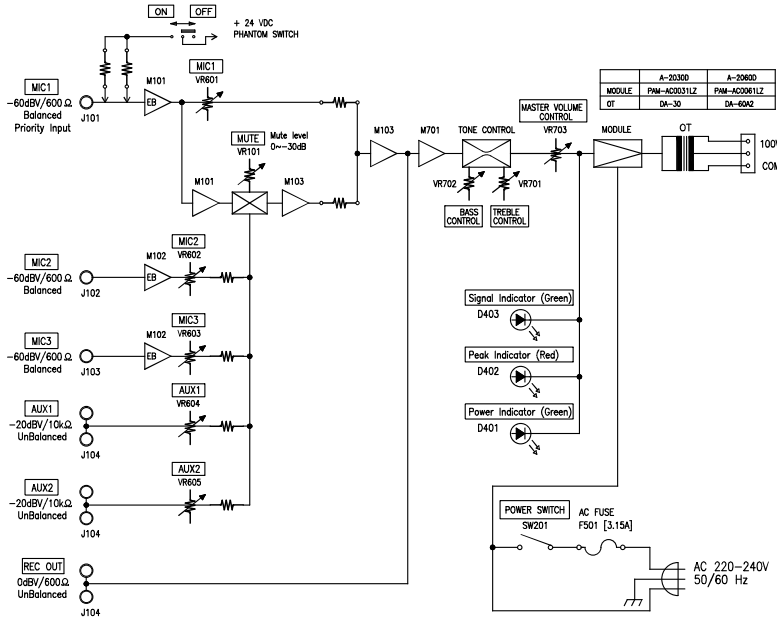

## [A-2120D-AS/A-2240D-AS]

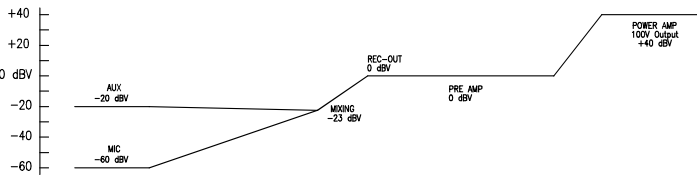
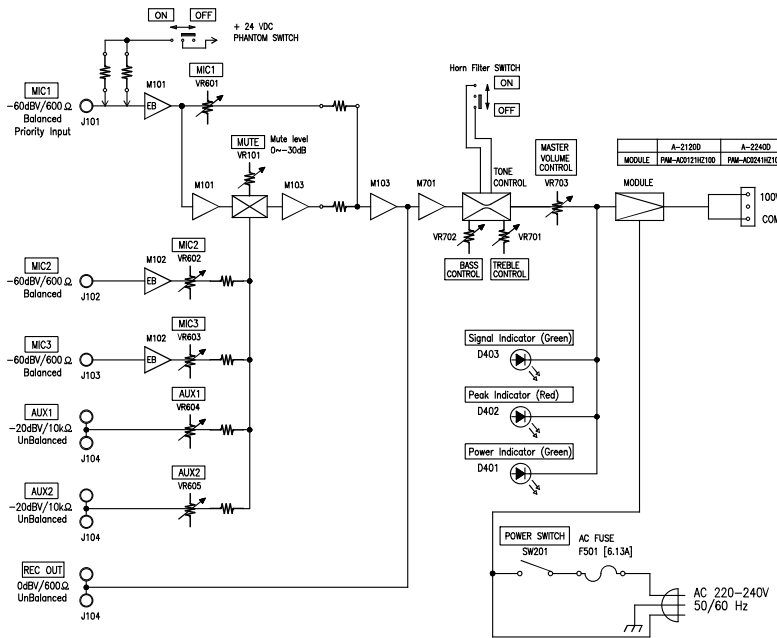

## 10. DIMENSIONAL DIAGRAM

Dimensional diagram represent by A-2030D-AS image. Outer dimension for all series are same.  
Units : mm (inches)

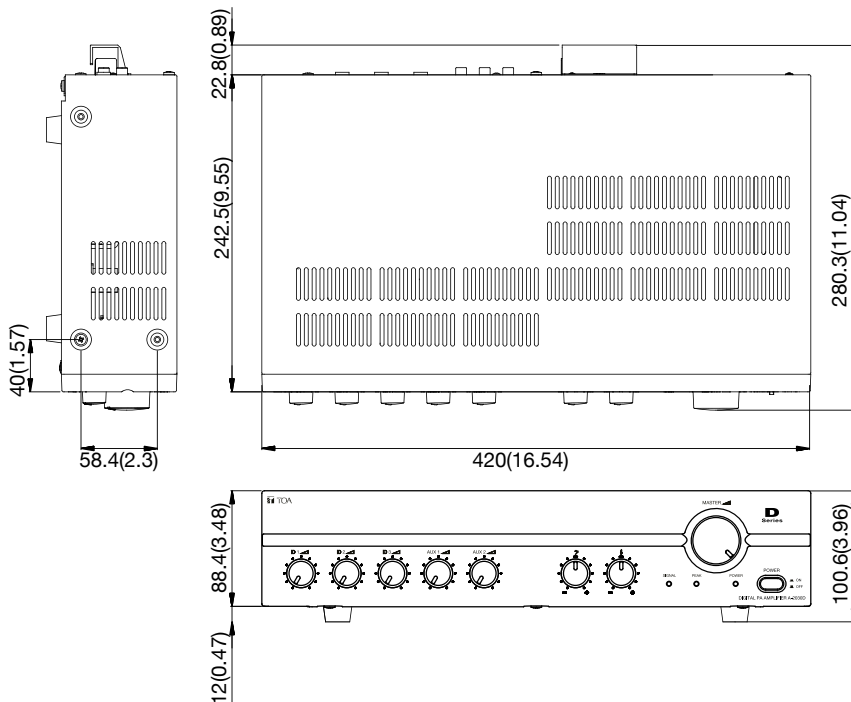

## 11. SPECIFICATIONS

Model no.	A-2030D-AS	A-2060D-AS	A-2120D-AS	A-2240D-AS
Power Source	220-240V~ 50/60Hz			
Rated Output	30W	60W	120W	240W
Power Consumption(EN 60065)	12W	16W	30W	48W
Frequency Response	50-20000Hz, ±3dB			
Distortion	Less than 1% at 1kHz, 1/3 Rated Power			
Input	MIC 1-3	-60 dB (0dB=1V), 600Ω, Balanced Phone Jack		
	AUX 1-2	-20 dB (0dB=1V), 10kΩ, Unbalanced RCA pin jack		
Output	Speaker out	Balanced (Floating)		
	Line 100V	330Ω	170Ω	83Ω
	Rec Out	0dB (1V), 600Ω, Unbalanced RCA pin jack		
Phantom Power	DC +21V (MIC 1)			
S/N Ratio	Over 60dB			
Tone Control	Bass ±10dB at 100Hz			
	Treble ±10dB at 10kHz			
Muting	MIC 1 : mute other input signal by 0-30dB attenuation			
Indicator	POWER, PEAK, SIGNAL			
Finish	Panel : ABS Resin, Black			
	Case : Steel Plate, Black			
Dimensions	420 (W) x 100.6 (H) x 280.3 (D) mm (16.54" x 3.96" x 11.04")			
Weight	4.0 kg (8.88 lb)	4.6 kg (10.14 lb)	4.0 kg (8.88 lb)	4.0 kg (8.88 lb)

\*Design & specification are subject to change without notice for improvement.